

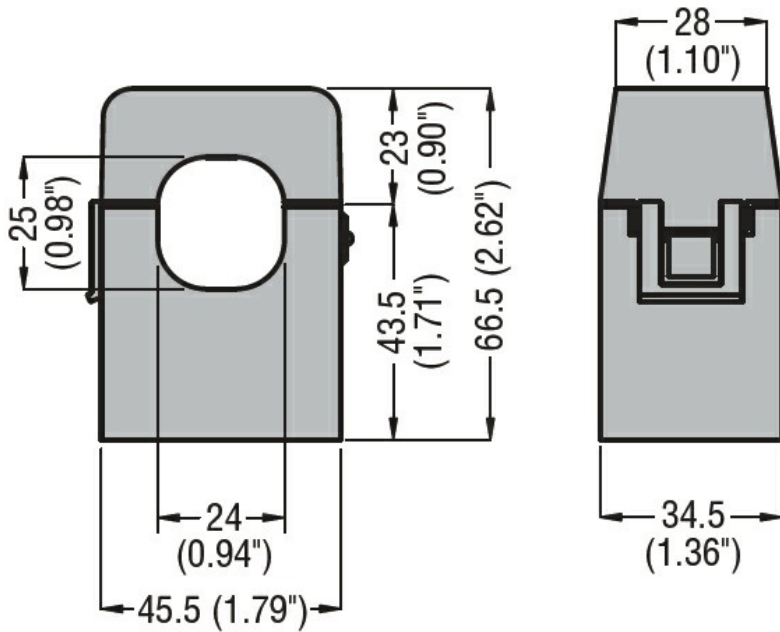

Product designation	Current transformers		
Product type designation	DM1TMA0150		
Type of CT	Split-core		
<b>Current inputs</b>			
Primary current I <sub>pn</sub> (/5)	A	150	
Operational frequency	min	Hz	50
	max	Hz	60
Secondary output current	A	5	
Overload withstand I <sub>pn</sub>	%	120	
Burden	cl. 1	VA	1
<b>Insulations</b>			
Rated insulation voltage U <sub>i</sub> IEC/EN	V	720	
IEC rated short-time thermal current I <sub>th</sub>	I <sub>th</sub> for s	40...60	
IEC rated dynamic current I <sub>dyn</sub>	I <sub>th</sub> for s	2.5	
Insulation dry type	Class E		
<b>Mechanical features</b>			
Terminals type	2m pre-wired		
Weight	g	200	
<b>Ambient conditions</b>			
Temperature	Operating temperature		
	min	°C	-25
	max	°C	+50
	Storage temperature		
min	°C	-40	
max	°C	+80	
Relative humidity	%	90	
<b>Dimensions</b>			



**Certifications and compliance**

Certifications

IEC/EN/BS 61869-1

IEC/EN/BS 61869-2

Compliance

EAC

**ETIM classification**

EC000066 - Power contactor, AC switching