



Product designation

Current
transformers
DM0TW0020
Wound primary

Product type designation

Type of CT

Current inputs

Primary current I_{pn} (/5)	A	20
Operational frequency	min	Hz 50
	max	Hz 60
Secondary output current	A	5
Overload withstand I_{pn}	%	120
Burden	cl. 1	VA 3.75

Insulations

IEC rated short-time thermal current I_{th}	I_{th} for s	40...60
IEC rated dynamic current I_{dyn}	I_{th} for s	2.5
Insulation dry type		Class E

Mechanical features

Terminals type		Screw
Fixing		DIN rail or by Screw
Weight	g	279

Ambient conditions

Temperature	Operating temperature	min	°C	-25
		max	°C	+50
	Storage temperature	min	°C	-40
		max	°C	+80
Relative humidity		%	90	
Protection degree			IP30	

Dimensions

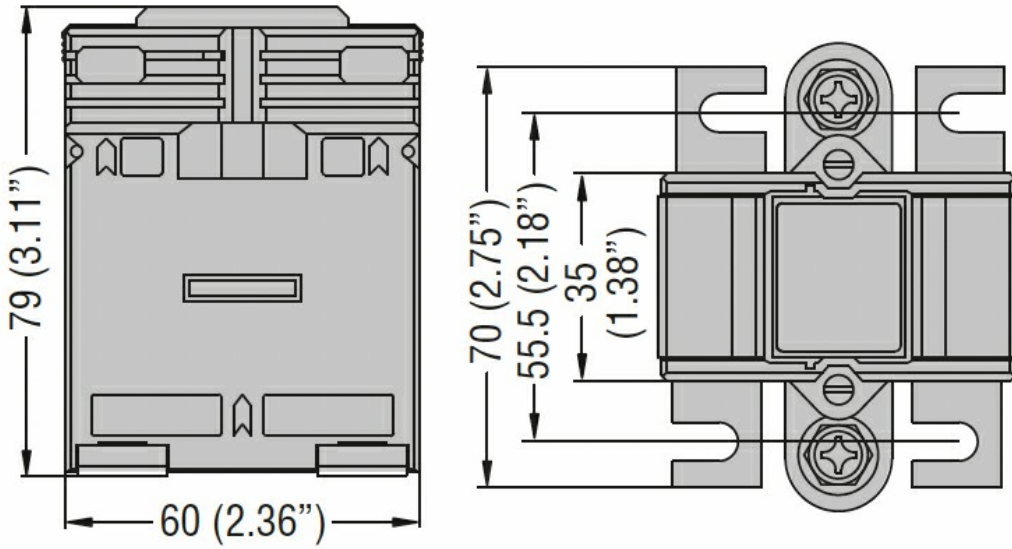

Certifications and compliance

Certifications

IEC/EN/BS 61869-1

IEC/EN/BS 61869-2

Compliance

CE

EAC

UKCA

ETIM classification

EC000066 - Power contactor, AC switching