

Product designation				Power contactor
Product type designation				DPBF32
Contact characteristics				
Number of poles			Nr.	3
Operational frequency				
	min	Hz	25	
	max	Hz	400	
Mechanical features				
Operating position			normal allowable	Vertical plan ±30°
Fixing				Screw / DIN rail 35mm
Weight			g	422
Operations				
Mechanical life			cycles	20000000
Electrical life			cycles	1600000
Safety related data				
Performance level B10d according to EN/ISO 13489-1			rated load mechanical load	cycles 1600000 cycles 20000000
Mirror contacts according to IEC/EN 60947-4-1				yes
EMC compatibility				yes
AC coil operating				
Rated AC voltage at 60Hz			V	230
AC operating voltage	of 60Hz coil powered at 60Hz			
	pick-up			
	min	%Us	80	
	max	%Us	110	
	drop-out			
	min	%Us	20	
	max	%Us	55	
AC average coil consumption at 20°C	of 60Hz coil powered at 60Hz			
	in-rush	VA	75	
	holding	VA	9	
Dissipation at holding ≤20°C 50Hz			W	2.5
Max cycles frequency				
Mechanical operation			cycles/h	3600
Operating times				
Average time for Us control	in AC			
	Closing NO			
	min	ms	8	
	max	ms	24	
	Opening NO			
	min	ms	5	
	max	ms	15	
	Closing NC			
	min	ms	9	
	max	ms	20	
	Opening NC			

min	ms	9
max	ms	17

UL technical data

Full-load current (FLA) for three-phase AC motor

at 600V	A	50
---------	---	----

Locked rotor current (LRA)

A	300
---	-----

Yielded mechanical performance

for single-phase AC motor

110/120V	HP	3
230V	HP	10

for three-phase AC motor

200/208V	HP	15
220/230V	HP	15
460/480V	HP	30
575/600V	HP	40

General USE

Contactor

AC current	A	55
------------	---	----

Short-circuit protection fuse, 600V

Standard fault

Short circuit current	kA	5
Fuse rating	A	150
Fuse class		RK5

Ambient conditions

Temperature

Operating temperature

min	°C	-50
max	°C	70

Storage temperature

min	°C	-60
max	°C	80

Max altitude

m	3000
---	------

Resistance & Protection

Pollution degree

3

Dimensions

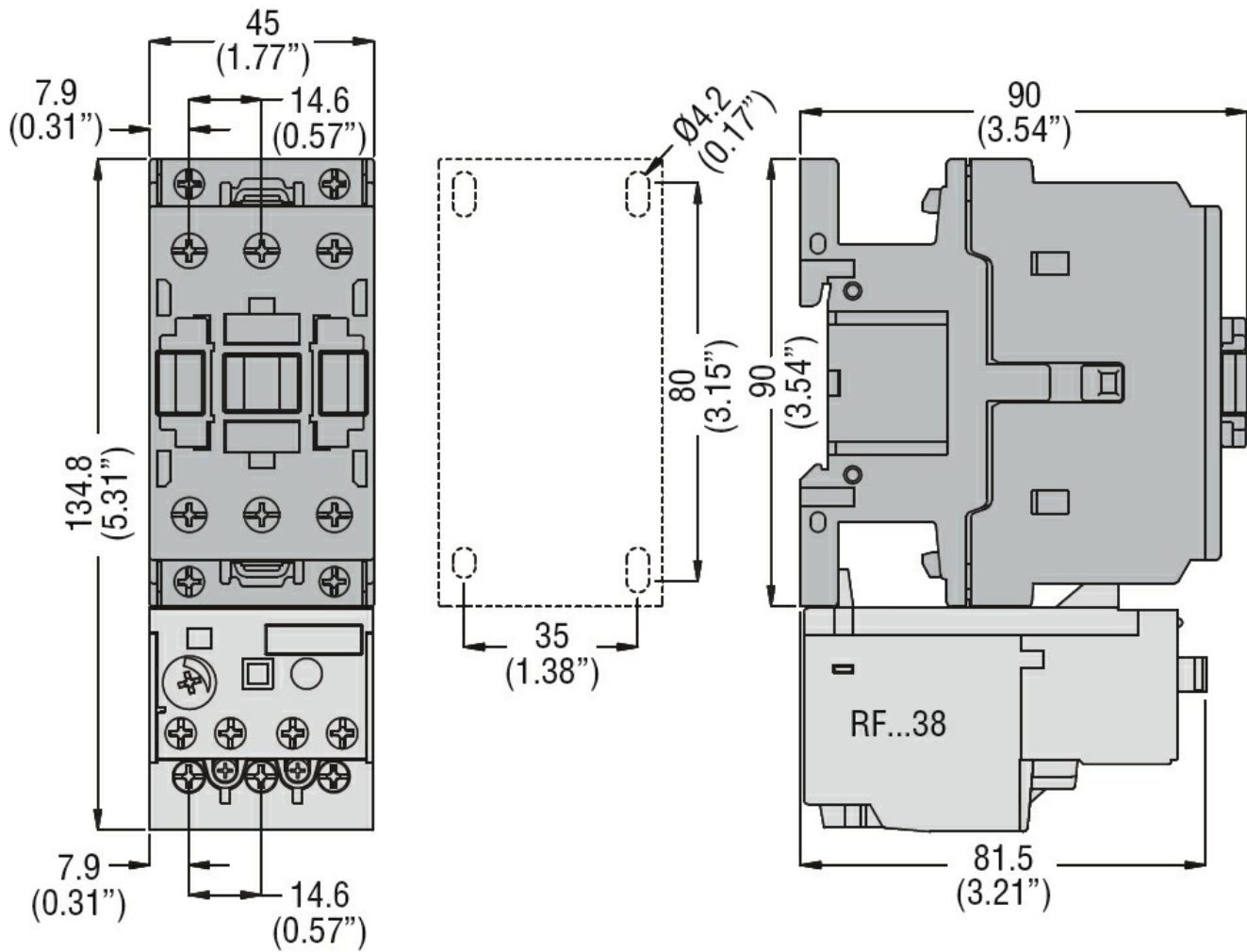

Wiring diagrams

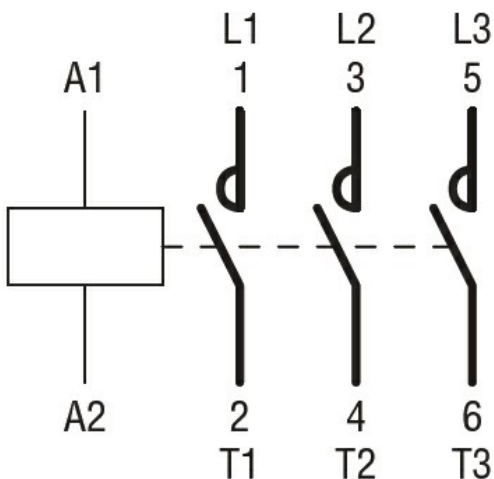

Certifications and compliance

Compliance

- CSA C22.2 n° 60947-1
- CSA C22.2 n° 60947-4-56
- UL 60947-1
- UL 60947-4-1

Certificates

cULus

ETIM classification

ETIM 8.0

EC000066 -
Power contactor,
AC switching