



Product designation				Power contactor
Product type designation				DPBF09
Contact characteristics				
Number of poles	Nr.			4
Operational frequency	min	Hz	25	
	max	Hz	400	
Mechanical features				
Operating position	normal allowable			Vertical plan ±30°
Fixing				Screw / DIN rail 35mm
Weight			g	352
Operations				
Mechanical life			cycles	20000000
Electrical life			cycles	2000000
Safety related data				
Performance level B10d according to EN/ISO 13489-1	rated load mechanical load	cycles cycles	2000000 20000000	
Mirror contacts according to IEC/EN 60947-4-1				yes
EMC compatibility				yes
AC coil operating				
Rated AC voltage at 60Hz			V	120
AC operating voltage of 60Hz coil powered at 60Hz	pick-up	min	%Us	80
		max	%Us	110
	drop-out	min	%Us	20
		max	%Us	55
AC average coil consumption at 20°C of 60Hz coil powered at 60Hz	in-rush	VA	75	
	holding	VA	9	
Dissipation at holding ≤20°C 50Hz			W	2.5
Max cycles frequency				
Mechanical operation				cycles/h 3600
Operating times				
Average time for Us control in AC	Closing NO		min	ms
				8

Opening NO	max	ms	24
	min	ms	10
Closing NC	max	ms	20
	min	ms	14
Opening NC	max	ms	28
	min	ms	7
	max	ms	18

UL technical data

Full-load current (FLA) for three-phase AC motor

at 600V A 20

Locked rotor current (LRA)

A 120

Yielded mechanical performance

for single-phase AC motor

110/120V HP 1.5
230V HP 3

for three-phase AC motor

200/208V HP 5
220/230V HP 5
460/480V HP 10
575/600V HP 15

General USE

Contactor

AC current A 25

Short-circuit protection fuse, 600V

Standard fault

Short circuit current kA 5
Fuse rating A 70
Fuse class RK5

Ambient conditions

Temperature

Operating temperature

min °C -50
max °C 70

Storage temperature

min °C -60
max °C 80

Max altitude

m 3000

Resistance & Protection

Pollution degree

3

Dimensions



Wiring diagrams

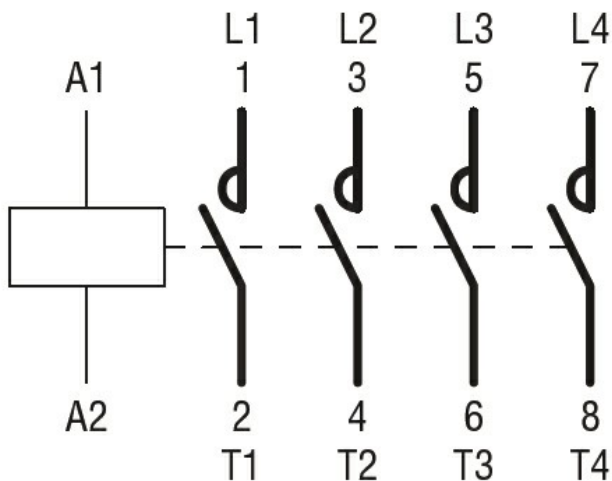

Certifications and compliance

Compliance

CSA C22.2 n° 60947-1

CSA C22.2 n° 60947-4-13

UL 60947-1

UL 60947-4-1

Certificates

cULus

ETIM classification

ETIM 8.0

EC000066 -
Power contactor,
AC switching