



Product designation

Product type designation

Mechanical features

Weight

g 270

Dimensions

Rigid connecting kits for star-delta starter. For BF95...BF150 BFX3431

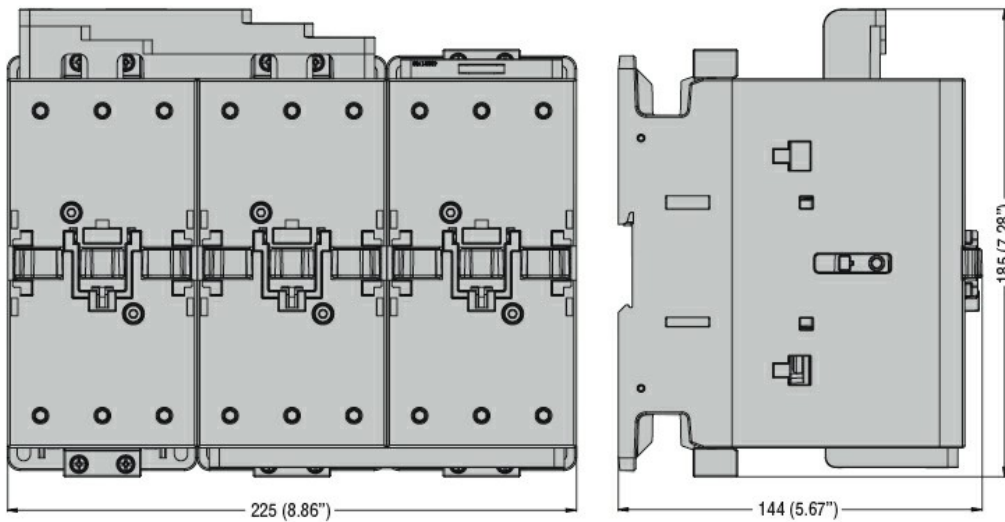

Wiring diagrams

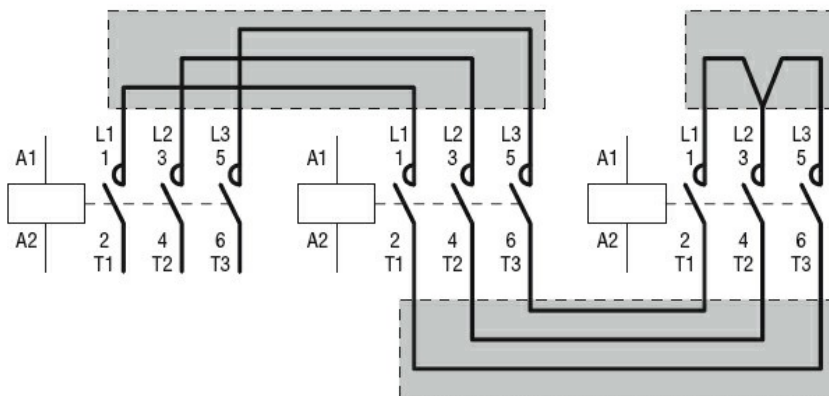

Certifications and compliance

Compliance

CSA C22.2 n° 60947-1

IEC/EN 60947-1

UL 60947-1

Certificates

cULus

EAC

ETIM classification

ETIM 8.0

EC002498 -
Accessories/spare
parts for low-
voltage switch
technology