

Rigid connecting kits for star-delta starter. For BF26...BF38 (L/Δ) BF09...BF25 (Λ) BFX3232

Product designation

Product type designation

Mechanical features

Weight

g 64

Dimensions

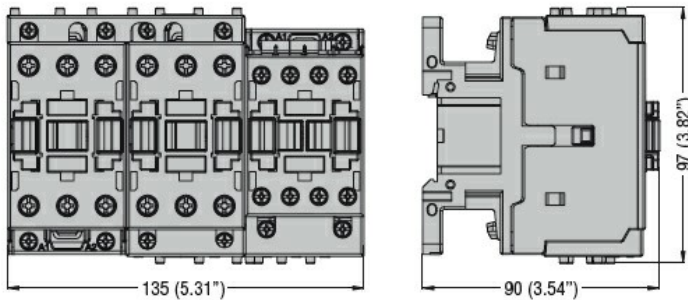

Wiring diagrams

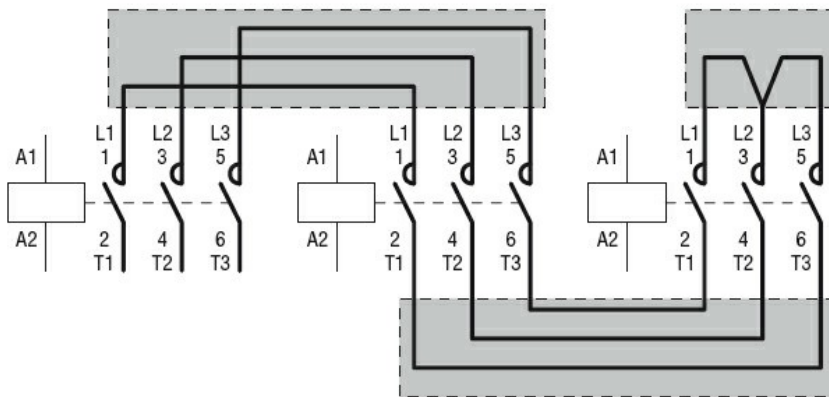

Certifications and compliance

Compliance

CSA C22.2 n° 60947-1
IEC/EN 60947-1
UL 60947-1

Certificates

cULus
EAC

ETIM classification

ETIM 8.0

EC002498 -
Accessories/spare
parts for low-
voltage switch
technology