



Product designation	Power contactor		
Product type designation	BF80		
Contact characteristics			
Number of poles	Nr.	4	
Rated insulation voltage U _i IEC/EN	V	1000	
Rated impulse withstand voltage U _{imp}	kV	8	
Operational frequency	min	Hz	25
	max	Hz	400
IEC Conventional free air thermal current I _{th}	A	115	
Operational current I _e	AC-1 (≤40°C)	A	115
	AC-1 (≤55°C)	A	95
	AC-1 (≤70°C)	A	80
	AC-3 (≤440V ≤55°C)	A	80
	AC-4 (400V)	A	38
Rated operational current AC-3 (T≤55°C)	230V	A	80
	400V	A	80
	415V	A	80
	440V	A	80
	500V	A	78
	690V	A	57
	1000V	A	28
Rated operational power AC-1 (T≤40°C)	230V	kW	43
	400V	kW	76
	500V	kW	95
	690V	kW	120
Short-time allowable current for 10s (IEC/EN60947-1)	A	640	
Protection fuse	gG (IEC)	A	125
	aM (IEC)	A	80
Making capacity (RMS value)	A	800	
Breaking capacity at voltage	440V	A	640
	500V	A	625
	690V	A	456
Resistance per pole (average value)	mΩ	0.6	
Power dissipation per pole (average value)	I _{th}	W	7.9
	AC-3	W	3.8
Tightening torque for terminals	min	Nm	4
	max	Nm	5

		min	Ibin	2.95
		max	Ibin	3.69
Tightening torque for coil terminal				
		min	Nm	0.8
		max	Nm	1
		min	Ibin	0.8
		max	Ibin	0.74
Max number of wires simultaneously connectable				Nr. 2
Conductor section				
	AWG/Kcmil			
		max		2
Flexible w/o lug conductor section				
		min	mm ²	1.5
		max	mm ²	35
Flexible c/w lug conductor section				
		min	mm ²	1.5
		max	mm ²	35
Power terminal protection according to IEC/EN 60529				IP20 front
Mechanical features				
Operating position				
		normal allowable		Vertical plan ±30°
Fixing				Screw / DIN rail 35mm
Weight			g	1360
Conductor section				
	AWG/kcmil conductor section			
		max		2
Operations				
Mechanical life			cycles	15000000
Electrical life			cycles	1300000
Safety related data				
Performance level B10d according to EN/ISO 13489-1				
		rated load	cycles	1300000
		mechanical load	cycles	15000000
Mirror contacts according to IEC/EN 60947-4-1				YES
EMC compatibility				yes
AC coil operating				
Rated AC voltage at 60Hz			V	24
AC operating voltage				
	of 60Hz coil powered at 60Hz			
	pick-up	min	%Us	80
		max	%Us	110
	drop-out	min	%Us	20
		max	%Us	55
AC average coil consumption at 20°C				
	of 60Hz coil powered at 60Hz			
		in-rush	VA	210
		holding	VA	15
Dissipation at holding ≤20°C 50Hz			W	5
Max cycles frequency				

Mechanical operation cycles/h 3600

Operating times

Average time for Us control
in AC

Closing NO	min	ms	12
	max	ms	28
Opening NO	min	ms	8
	max	ms	22
Closing NC	min	ms	11
	max	ms	29
Opening NC	min	ms	6
	max	ms	14

in DC

Closing NO	min	ms	40
	max	ms	85
Opening NO	min	ms	20
	max	ms	55

UL technical data

Full-load current (FLA) for three-phase AC motor

at 480V	A	77
at 600V	A	77

Yielded mechanical performance

for three-phase AC motor

200/208V	HP	25
220/230V	HP	30
460/480V	HP	60
575/600V	HP	75

General USE

Contactor

AC current	A	115
------------	---	-----

Ambient conditions

Temperature

Operating temperature

min	°C	-50
max	°C	70

Storage temperature

min	°C	-60
max	°C	80

Max altitude

m	3000
---	------

Resistance & Protection

Pollution degree

3

Dimensions

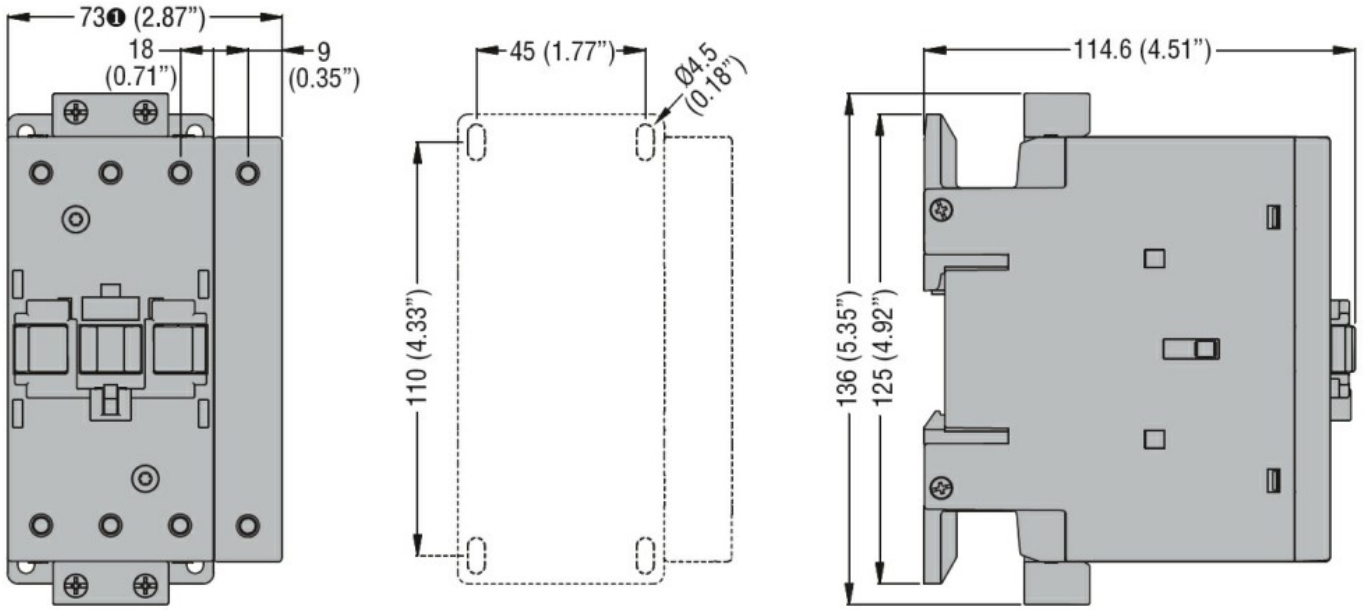

① BF80T2 82mm/3.23"

Wiring diagrams

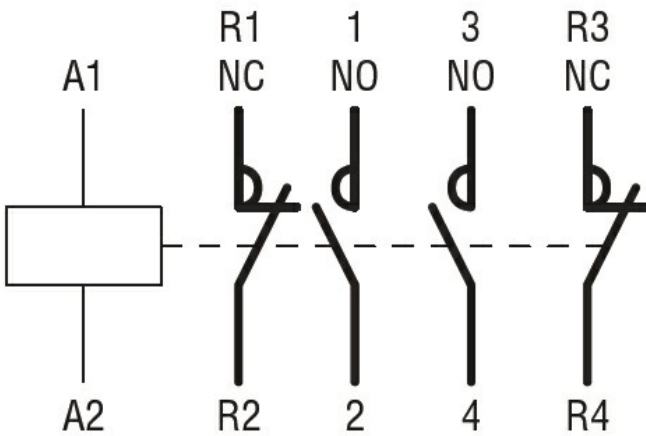

Certifications and compliance

Compliance

CSA C22.2 n° 60947-1

CSA C22.2 n° 60947-4-1

IEC/EN/BS 60947-1

IEC/EN/BS 60947-4-1

UL 60947-1

UL 60947-4-1

Certificates

CCC

cULus

ETIM classification

ETIM 8.0

EC000066 -
Power contactor,
AC switching