



Product designation	Power contactor		
Product type designation	BF26		
Contact characteristics			
Number of poles	Nr.	4	
Rated insulation voltage U _i IEC/EN	V	690	
Rated impulse withstand voltage U _{imp}	kV	6	
Operational frequency	min	Hz	25
	max	Hz	400
IEC Conventional free air thermal current I _{th}	A	45	
Operational current I _e	AC-1 (≤40°C)	A	45
	AC-1 (≤55°C)	A	36
	AC-1 (≤70°C)	A	32
	AC-3 (≤440V ≤55°C)	A	26
	AC-4 (400V)	A	11.5
Rated operational power AC-1 (T≤40°C)	230V	kW	17
	400V	kW	30
	500V	kW	37
	690V	kW	51
Short-time allowable current for 10s (IEC/EN60947-1)	A	210	
Protection fuse	gG (IEC)	A	50
	aM (IEC)	A	32
Making capacity (RMS value)	A	260	
Breaking capacity at voltage	440V	A	208
	500V	A	184
	690V	A	168
Resistance per pole (average value)	mΩ	2	
Power dissipation per pole (average value)	I _{th}	W	4
	AC-3	W	1.4
Tightening torque for terminals	min	Nm	2.5
	max	Nm	3
	min	I _{bin}	1.8
	max	I _{bin}	2.2
Tightening torque for coil terminal	min	Nm	0.8
	max	Nm	1
	min	I _{bin}	0.8
	max	I _{bin}	0.74
Max number of wires simultaneously connectable	Nr.	2	

Conductor section

AWG/Kcmil			max	6
Flexible w/o lug conductor section			min	mm ² 2.5
			max	mm ² 16
Flexible c/w lug conductor section			min	mm ² 1
			max	mm ² 10
Flexible with insulated spade lug conductor section			min	mm ² 1
			max	mm ² 10

Power terminal protection according to IEC/EN 60529

IP20 when properly wired

Mechanical features

Operating position

normal allowable Vertical plan ±30°

Fixing

Screw / DIN rail 35mm

Weight

g 670

Conductor section

AWG/kcmil conductor section			max	6
-----------------------------	--	--	-----	---

Operations

Mechanical life

cycles 20000000

Electrical life

cycles 1600000

Safety related data

Performance level B10d according to EN/ISO 13489-1

rated load cycles 1600000
mechanical load cycles 20000000

Mirror contacts according to IEC/EN 60947-4-1

YES

EMC compatibility

yes

DC coil operating

DC rated control voltage

V 125

DC operating voltage

pick-up

min %Us 80
max %Us 125

drop-out

min %Us 10
max %Us 40

Average coil consumption ≤20°C

in-rush W 5.4
holding W 5.4

Max cycles frequency

Mechanical operation

cycles/h 3600

Operating times

Average time for Us control

in AC

Closing NO

min ms 8
max ms 24

Opening NO	min	ms	5
	max	ms	15
Closing NC	min	ms	9
	max	ms	20
Opening NC	min	ms	9
	max	ms	17
<hr/>			
in DC			
Closing NO	min	ms	54
	max	ms	66
Opening NO	min	ms	14
	max	ms	17
Closing NC	min	ms	23
	max	ms	28
Opening NC	min	ms	46
	max	ms	56

UL technical data

Full-load current (FLA) for three-phase AC motor

at 480V	A	21
at 600V	A	22

Yielded mechanical performance

for single-phase AC motor

110/120V	HP	2
230V	HP	5

for three-phase AC motor

200/208V	HP	7.5
220/230V	HP	7.5
460/480V	HP	15
575/600V	HP	20

General USE

Contactor

AC current	A	45
------------	---	----

Ambient conditions

Temperature

Operating temperature

min	°C	-50
max	°C	70

Storage temperature

min	°C	-60
max	°C	80

Max altitude

m	3000
---	------

Resistance & Protection

Pollution degree

3

Dimensions

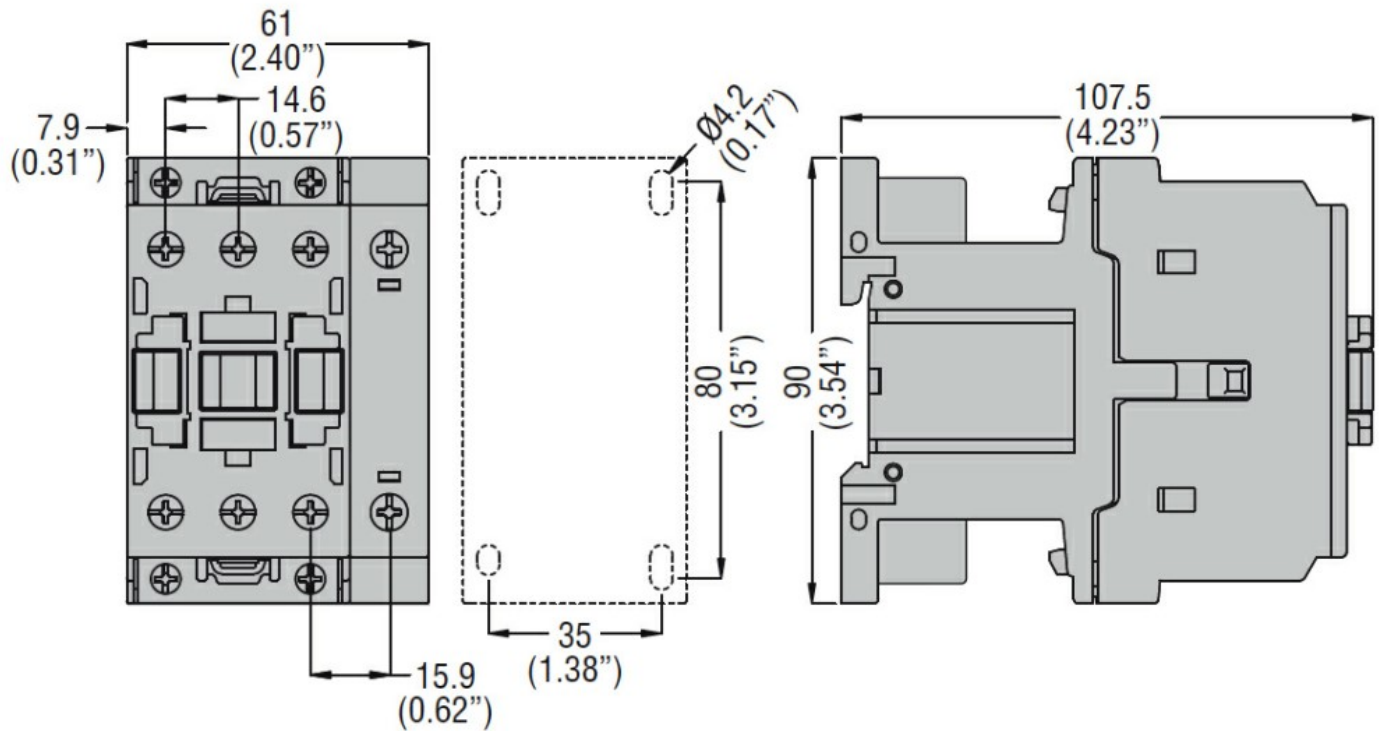

Wiring diagrams

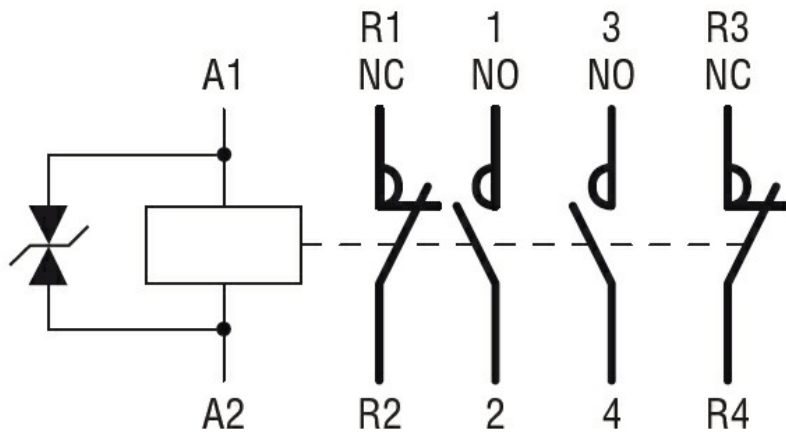

Certifications and compliance

Compliance

CSA C22.2 n° 60947-1

CSA C22.2 n° 60947-4-1

IEC/EN/BS 60947-1

IEC/EN/BS 60947-4-1

UL 60947-1

UL 60947-4-1

Certificates

CCC

cULus

EAC

ETIM classification

ETIM 8.0

EC000066 -
Power contactor,
AC switching