



Product designation				Power contactor
Product type designation				BF09
Contact characteristics				
Number of poles	Nr.			4
Rated insulation voltage U _i IEC/EN	V			690
Rated impulse withstand voltage U _{imp}	kV			6
Operational frequency	min	Hz	25	
	max	Hz	400	
IEC Conventional free air thermal current I _{th}	A			25
Operational current I _e	AC-1 (≤40°C)	A	25	
	AC-1 (≤55°C)	A	20	
	AC-1 (≤70°C)	A	18	
	AC-3 (≤440V ≤55°C)	A	9	
	AC-4 (400V)	A	4.9	
Rated operational power AC-1 (T≤40°C)	230V	kW	9.5	
	400V	kW	16	
	500V	kW	21	
	690V	kW	27	
Short-time allowable current for 10s (IEC/EN60947-1)	A			150
Protection fuse	gG (IEC)	A	25	
	aM (IEC)	A	10	
Making capacity (RMS value)	A			90
Breaking capacity at voltage	440V	A	72	
	500V	A	72	
	690V	A	71	
Resistance per pole (average value)	mΩ			2.5
Power dissipation per pole (average value)	I _{th}	W	1.6	
	AC-3	W	0.2	
Tightening torque for terminals	min	Nm	1.5	
	max	Nm	1.8	
	min	I _{bin}	1.1	
	max	I _{bin}	1.5	
Tightening torque for coil terminal	min	Nm	0.8	
	max	Nm	1	
	min	I _{bin}	0.8	
	max	I _{bin}	0.74	
Max number of wires simultaneously connectable	Nr.			2

Conductor section	AWG/Kcmil			
		max		10
Flexible w/o lug conductor section		min	mm ²	1
		max	mm ²	6
Flexible c/w lug conductor section		min	mm ²	1
		max	mm ²	4
Flexible with insulated spade lug conductor section		min	mm ²	1
		max	mm ²	4

Power terminal protection according to IEC/EN 60529 IP20 when properly wired

Mechanical features

Operating position	normal allowable	Vertical plan ±30°
Fixing		Screw / DIN rail 35mm
Weight		g 348

Conductor section	AWG/kcmil conductor section	max	10
-------------------	-----------------------------	-----	----

Operations

Mechanical life	cycles	20000000
Electrical life	cycles	2000000

Safety related data

Performance level B10d according to EN/ISO 13489-1	rated load mechanical load	cycles	2000000
		cycles	20000000
Mirror contacts according to IEC/EN 609474-4-1			YES
EMC compatibility			yes

AC coil operating

Rated AC voltage at 60Hz	V	575
AC operating voltage		
of 60Hz coil powered at 60Hz		
pick-up	min %Us	80
	max %Us	110
drop-out	min %Us	20
	max %Us	55

AC average coil consumption at 20°C			
of 60Hz coil powered at 60Hz			
	in-rush holding	VA	75
		VA	9

Dissipation at holding ≤20°C 50Hz	W	2.5
-----------------------------------	---	-----

Max cycles frequency

Mechanical operation	cycles/h	3600
----------------------	----------	------

Operating times

Average time for Us control in AC		
-----------------------------------	--	--

Closing NO	min	ms	8
	max	ms	24
Opening NO	min	ms	10
	max	ms	20
Closing NC	min	ms	14
	max	ms	28
Opening NC	min	ms	7
	max	ms	18

UL technical data

Full-load current (FLA) for three-phase AC motor

at 480V	A	7.6
at 600V	A	9

Yielded mechanical performance

for single-phase AC motor

110/120V	HP	0.8
230V	HP	2

for three-phase AC motor

200/208V	HP	3
220/230V	HP	3
460/480V	HP	5
575/600V	HP	7.5

General USE

Contactor

AC current	A	25
------------	---	----

Ambient conditions

Temperature

Operating temperature

min	°C	-50
max	°C	70

Storage temperature

min	°C	-60
max	°C	80

Max altitude

m	3000
---	------

Resistance & Protection

Pollution degree

3

Dimensions



Wiring diagrams

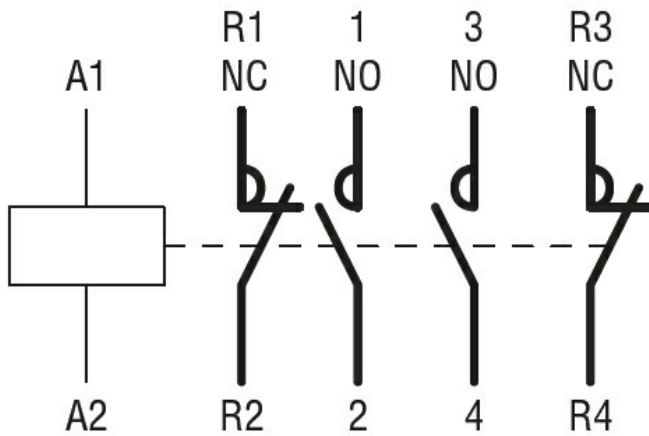

Certifications and compliance

Compliance

CSA C22.2 n° 60947-1
CSA C22.2 n° 60947-4-1
IEC/EN/BS 60947-1
IEC/EN/BS 60947-4-1
UL 60947-1
UL 60947-4-1

Certificates

CCC
cULus
EAC

ETIM classification

ETIM 8.0

EC000066 -
Power contactor,
AC switching