



Product designation				Power contactor
Product type designation				BF09
Contact characteristics				
Number of poles	Nr.			3
Rated insulation voltage U_i IEC/EN	V			690
Rated impulse withstand voltage U_{imp}	kV			6
Operational frequency	min	Hz	25	
	max	Hz	400	
IEC Conventional free air thermal current I_{th}	A			25
Operational current I_e	AC-1 ($\leq 40^\circ\text{C}$)	A	25	
	AC-1 ($\leq 55^\circ\text{C}$)	A	20	
	AC-1 ($\leq 70^\circ\text{C}$)	A	18	
	AC-3 ($\leq 440\text{V} \leq 55^\circ\text{C}$)	A	9	
	AC-4 (400V)	A	4.9	
Rated operational power AC-3 ($T \leq 55^\circ\text{C}$)	230V	kW	2.2	
	400V	kW	4.2	
	415V	kW	4.5	
	440V	kW	4.8	
	500V	kW	5.5	
	690V	kW	7.5	
Rated operational power AC-1 ($T \leq 40^\circ\text{C}$)	230V	kW	9.5	
	400V	kW	16	
	500V	kW	21	
	690V	kW	27	
IEC max current I_e in DC1 with $L/R \leq 1\text{ms}$ with 1 poles in series	$\leq 24\text{V}$	A	15	
	48V	A	13	
	75V	A	12	
	110V	A	6	
	220V	A	-	
IEC max current I_e in DC1 with $L/R \leq 1\text{ms}$ with 2 poles in series	$\leq 24\text{V}$	A	18	
	48V	A	18	
	75V	A	17	
	110V	A	12	
	220V	A	1	
IEC max current I_e in DC1 with $L/R \leq 1\text{ms}$ with 3 poles in series	$\leq 24\text{V}$	A	20	
	48V	A	20	
	75V	A	20	
	110V	A	15	

	220V	A	10
IEC max current I _e in DC1 with L/R ≤ 1ms with 4 poles in series	≤24V	A	20
	48V	A	20
	75V	A	20
	110V	A	16
	220V	A	12
IEC max current I _e in DC3-DC5 with L/R ≤ 15ms with 1 poles in series	≤24V	A	10
	48V	A	9
	75V	A	8
	110V	A	2
	220V	A	–
IEC max current I _e in DC3-DC5 with L/R ≤ 15ms with 2 poles in series	≤24V	A	13
	48V	A	11
	75V	A	10
	110V	A	7
	220V	A	2
IEC max current I _e in DC3-DC5 with L/R ≤ 15ms with 3 poles in series	≤24V	A	15
	48V	A	15
	75V	A	13
	110V	A	11
	220V	A	6
IEC max current I _e in DC3-DC5 with L/R ≤ 15ms with 4 poles in series	≤24V	A	15
	48V	A	15
	75V	A	15
	110V	A	12
	220V	A	7
Short-time allowable current for 10s (IEC/EN60947-1)		A	150
Protection fuse	gG (IEC)	A	25
	aM (IEC)	A	10
Making capacity (RMS value)		A	90
Breaking capacity at voltage	440V	A	72
	500V	A	72
	690V	A	71
Resistance per pole (average value)		mΩ	2.5
Power dissipation per pole (average value)	I _{th}	W	1.6
	AC-3	W	0.2
Tightening torque for terminals	min	Nm	1.5
	max	Nm	1.8
	min	I _{bin}	1.1
	max	I _{bin}	1.5
Tightening torque for coil terminal	min	Nm	0.8
	max	Nm	1
	min	I _{bin}	0.8

		max	I _{bin}	0.74
Max number of wires simultaneously connectable			Nr.	2
Conductor section	AWG/Kcmil	max		10
Flexible w/o lug conductor section		min	mm ²	1
		max	mm ²	6
Flexible c/w lug conductor section		min	mm ²	1
		max	mm ²	4
Flexible with insulated spade lug conductor section		min	mm ²	1
		max	mm ²	4
Power terminal protection according to IEC/EN 60529				IP20 when properly wired

Mechanical features

Operating position		normal allowable		Vertical plan ±30°
Fixing				Screw / DIN rail 35mm
Weight			g	346
Conductor section	AWG/kcmil conductor section	max		10

Auxiliary contact characteristics

Thermal current I _{th}		A		10
IEC/EN 60947-5-1 designation				A600 - P600
Operating current AC15		230V	A	3
		400V	A	1.9
		500V	A	1.4
Operating current DC12		110V	A	5.7
Operating current DC13		24V	A	5.7
		48V	A	2.9
		60V	A	2.3
		110V	A	1.25
		125V	A	1.1
		220V	A	0.55
		600V	A	0.2

Operations

Mechanical life		cycles		20000000
Electrical life		cycles		2000000

Safety related data

Performance level B10d according to EN/ISO 13489-1		rated load	cycles	2000000
		mechanical load	cycles	20000000
Mirror contacts according to IEC/EN 60947-4-1				yes
EMC compatibility				yes

AC coil operating

Rated AC voltage at 60Hz	V	575
AC operating voltage		
of 60Hz coil powered at 60Hz		
pick-up	min %Us	80
	max %Us	110
drop-out	min %Us	20
	max %Us	55
AC average coil consumption at 20°C		
of 60Hz coil powered at 60Hz		
	in-rush VA	75
	holding VA	9
Dissipation at holding ≤20°C 50Hz	W	2.5
Max cycles frequency		
Mechanical operation	cycles/h	3600
Operating times		
Average time for Us control		
in AC		
Closing NO	min ms	8
	max ms	24
Opening NO	min ms	10
	max ms	20
Closing NC	min ms	14
	max ms	28
Opening NC	min ms	7
	max ms	18
UL technical data		
Full-load current (FLA) for three-phase AC motor		
	at 480V A	7.6
	at 600V A	0.375
Yielded mechanical performance		
for single-phase AC motor		
	110/120V HP	0.75
	230V HP	2
for three-phase AC motor		
	200/208V HP	3
	220/230V HP	3
	460/480V HP	5
	575/600V HP	7.5
General USE		
Contactor		
	AC current A	25
Auxiliary contacts		
	AC voltage V	600
	AC current A	10
	DC voltage V	250
	DC current A	1
Short-circuit protection fuse, 600V		
High fault		

Short circuit current	kA	100
Fuse rating	A	30
Fuse class		J

Standard fault

Short circuit current	kA	5
Fuse rating	A	60

Contact rating of auxiliary contacts according to UL

A600 - P600

Ambient conditions

Temperature

Operating temperature

min	°C	-50
max	°C	70

Storage temperature

min	°C	-60
max	°C	80

Max altitude

m 3000

Resistance & Protection

Pollution degree

3

Dimensions

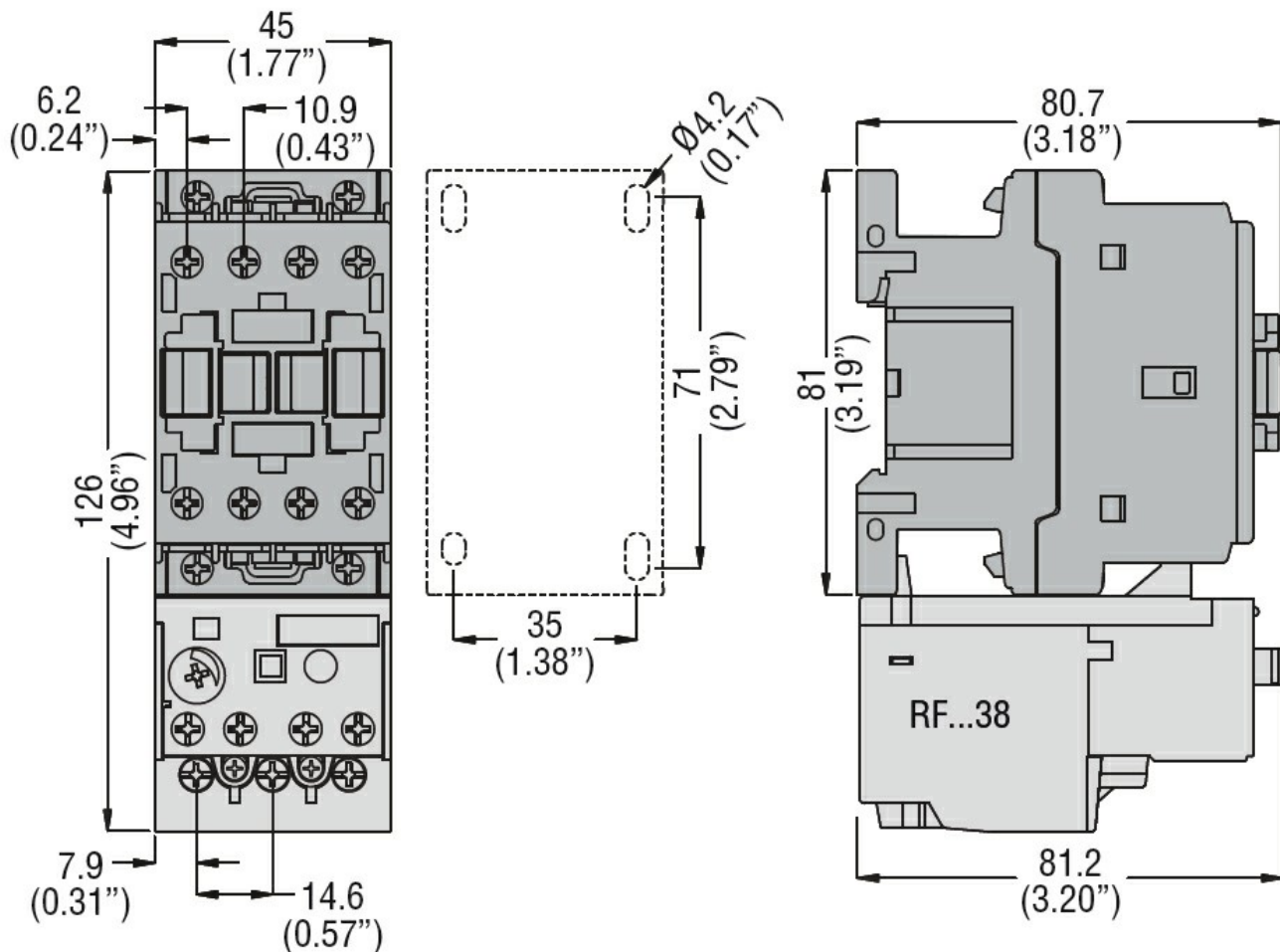

Wiring diagrams

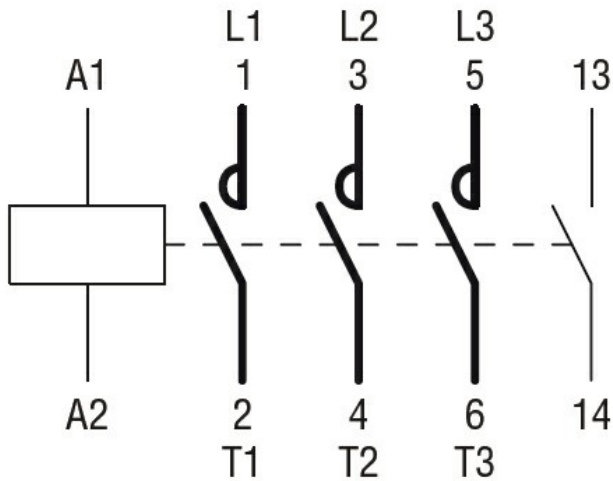

Certifications and compliance

Compliance

CSA C22.2 n° 60947-1

CSA C22.2 n° 60947-4-1

IEC/EN/BS 60947-1

IEC/EN/BS 60947-4-1

UL 60947-1

UL 60947-4-1

Certificates

CCC

cULus

EAC

ETIM classification

ETIM 8.0

EC000066 -
Power contactor,
AC switching