



Product designation	Power contactor		
Product type designation	BGP09		
Contact characteristics			
Number of poles	Nr.	4	
Rated insulation voltage U_i IEC/EN	V	500	
Rated impulse withstand voltage U_{imp}	kV	6	
Operational frequency	min	Hz	25
	max	Hz	400
IEC Conventional free air thermal current I_{th}	A	20	
Operational current I_e	AC-1 ($\leq 40^\circ\text{C}$)	A	20
	AC-1 ($\leq 55^\circ\text{C}$)	A	18
	AC-1 ($\leq 70^\circ\text{C}$)	A	15
	AC-3 ($\leq 440\text{V} \leq 55^\circ\text{C}$)	A	9
	AC-4 (400V)	A	4
Rated operational power AC-1 ($T \leq 40^\circ\text{C}$)	230V	kW	8
	400V	kW	14
	500V	kW	16
Short-time allowable current for 10s (IEC/EN60947-1)	A	96	
Protection fuse	gG (IEC)	A	20
	aM (IEC)	A	10
Making capacity (RMS value)	A	92	
Breaking capacity at voltage	440V	A	72
	500V	A	72
Resistance per pole (average value)	m Ω	10	
Power dissipation per pole (average value)	I_{th}	W	4
	AC-3	W	0.81
Tightening torque for terminals	min	Nm	0.8
	max	Nm	1
	min	Ibin	9
	max	Ibin	9
Tightening torque for coil terminal	min	Nm	0.8
	max	Nm	1
	min	Ibin	9
	max	Ibin	9
Max number of wires simultaneously connectable	Nr.	2	
Conductor section	AWG/Kcmil		

		max		12
Flexible w/o lug conductor section		min	mm ²	0.8
		max	mm ²	2.5
Flexible c/w lug conductor section		min	mm ²	1.5
		max	mm ²	2.5
Flexible with insulated spade lug conductor section		min	mm ²	1.5
		max	mm ²	2.5
Power terminal protection according to IEC/EN 60529				IP00
Mechanical features				
Operating position		normal allowable		Vertical plan ±30°
Fixing				Screw / DIN rail 35mm
Weight			g	186
Conductor section	AWG/kcmil conductor section			
		max		12
Auxiliary contact characteristics				
Thermal current I _{th}			A	10
IEC/EN 60947-5-1 designation				A600
Operations				
Mechanical life			cycles	20000000
Electrical life			cycles	500000
Safety related data				
Performance level B10d according to EN/ISO 13489-1		rated load mechanical load	cycles	500000
			cycles	20000000
Mirror contacts according to IEC/EN 60947-4-1				yes
EMC compatibility				yes
AC coil operating				
Rated AC voltage at 50/60Hz			V	110
AC operating voltage	of 50/60Hz coil powered at 50Hz			
	pick-up	min	%Us	75
		max	%Us	115
	drop-out	min	%Us	20
		max	%Us	55
	of 50/60Hz coil powered at 60Hz			
	pick-up	min	%Us	80
		max	%Us	115
	drop-out	min	%Us	20
		max	%Us	55
AC average coil consumption at 20°C	of 50/60Hz coil powered at 50Hz			
		in-rush holding	VA	30
			VA	4

of 50/60Hz coil powered at 60Hz

in-rush	VA	25
holding	VA	3

of 60Hz coil powered at 60Hz

in-rush	VA	30
holding	VA	4

Dissipation at holding $\leq 20^{\circ}\text{C}$ 50Hz

W	0.95
---	------

Max cycles frequency

Mechanical operation

cycles/h	3600
----------	------

Operating times

Average time for Us control

in AC

Closing NO

min	ms	12
max	ms	21

Opening NO

min	ms	9
max	ms	18

Closing NC

min	ms	17
max	ms	26

Opening NC

min	ms	7
max	ms	17

in DC

Closing NO

min	ms	18
max	ms	25

Opening NO

min	ms	2
max	ms	3

Closing NC

min	ms	3
max	ms	5

Opening NC

min	ms	11
max	ms	17

UL technical data

Full-load current (FLA) for three-phase AC motor

at 480V	A	7.6
at 600V	A	6.1

Yielded mechanical performance

for single-phase AC motor

110/120V	HP	0.5
230V	HP	1.5

for three-phase AC motor

200/208V	HP	2
220/230V	HP	3
460/480V	HP	5
575/600V	HP	5

General USE

Contactor

AC current	A	20
------------	---	----

Ambient conditions

Temperature

Operating temperature

min	°C	-50
max	°C	+70

Storage temperature

min	°C	-60
max	°C	+80

Max altitude

m	3000
---	------

Resistance & Protection

Pollution degree

3

Dimensions

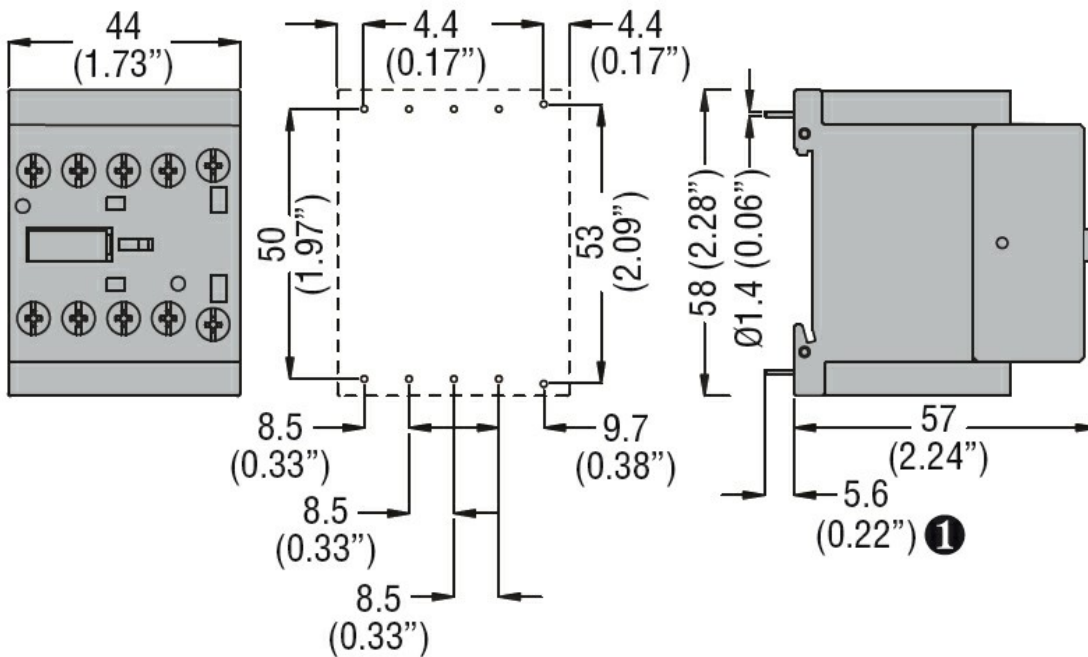

① Recommended PCB drillings 1.7-2mm.

Wiring diagrams

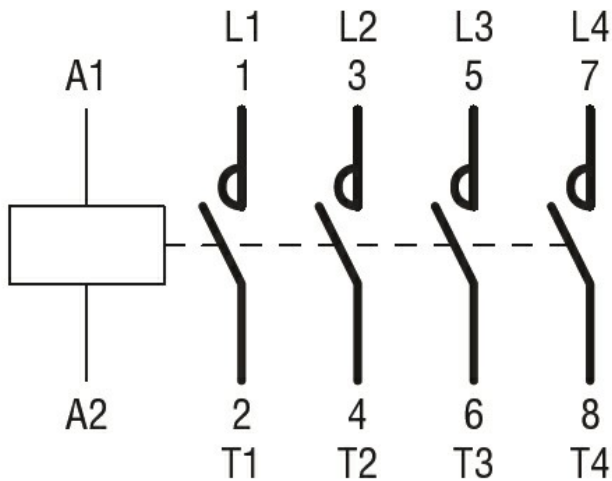

Certifications and compliance

Compliance

- CSA C22.2 n° 60947-1
- CSA C22.2 n° 60947-4-1
- IEC/EN 60947-1

IEC/EN 60947-4-1

UL 60947-1

UL 60947-4-1

Certificates

cURus

EAC

ETIM classification

ETIM 8.0

EC000066 -
Power contactor,
AC switching