



Product designation	Power contactor		
Product type designation	BGP09		
Contact characteristics			
Number of poles	Nr.	3	
Rated insulation voltage U_i IEC/EN	V	500	
Rated impulse withstand voltage U_{imp}	kV	6	
Operational frequency	min	Hz	25
	max	Hz	400
IEC Conventional free air thermal current I_{th}	A	20	
Operational current I_e	AC-1 ($\leq 40^\circ\text{C}$)	A	20
	AC-1 ($\leq 55^\circ\text{C}$)	A	18
	AC-1 ($\leq 70^\circ\text{C}$)	A	15
	AC-3 ($\leq 440\text{V} \leq 55^\circ\text{C}$)	A	9
	AC-4 (400V)	A	4
Rated operational power AC-3 ($T \leq 55^\circ\text{C}$)	230V	kW	2.2
	400V	kW	4
	415V	kW	4.3
	440V	kW	4.5
	500V	kW	5
Rated operational power AC-1 ($T \leq 40^\circ\text{C}$)	230V	kW	8
	400V	kW	14
	500V	kW	16
Short-time allowable current for 10s (IEC/EN60947-1)	A	96	
Protection fuse	gG (IEC)	A	20
	aM (IEC)	A	10
Making capacity (RMS value)	A	92	
Breaking capacity at voltage	440V	A	72
	500V	A	72
Resistance per pole (average value)	m Ω	10	
Power dissipation per pole (average value)	I_{th}	W	4
	AC-3	W	0.81
Tightening torque for terminals	min	Nm	0.8
	max	Nm	1
	min	lbin	9
	max	lbin	9
Tightening torque for coil terminal	min	Nm	0.8

	max	Nm	1
	min	lbin	9
	max	lbin	9
Max number of wires simultaneously connectable		Nr.	2
Conductor section			
AWG/Kcmil	max		12
Flexible w/o lug conductor section	min	mm ²	0.8
	max	mm ²	2.5
Flexible c/w lug conductor section	min	mm ²	1.5
	max	mm ²	2.5
Flexible with insulated spade lug conductor section	min	mm ²	1.5
	max	mm ²	2.5
Power terminal protection according to IEC/EN 60529			IP00
Mechanical features			
Operating position	normal allowable		Vertical plan ±30°
Fixing			Screw / DIN rail 35mm
Weight		g	200
Conductor section			
AWG/kcmil conductor section	max		12
Auxiliary contact characteristics			
Thermal current I _{th}		A	10
IEC/EN 60947-5-1 designation			A600 - Q600
Operating current AC15	230V	A	3
	400V	A	1.9
	500V	A	1.4
Operating current DC12	110V	A	2.9
Operating current DC13	24V	A	2.9
	48V	A	1.4
	60V	A	1.1
	125V	A	0.3
	220V	A	0.1
	600V	A	0.6
Operations			
Mechanical life		cycles	20000000
Electrical life		cycles	500000
Safety related data			
Performance level B10d according to EN/ISO 13489-1	rated load	cycles	500000
	mechanical load	cycles	20000000
Mirror contacts according to IEC/EN 60947-4-1			yes
EMC compatibility			yes
AC coil operating			

Rated AC voltage at 50/60Hz	V	110
AC operating voltage		
of 50/60Hz coil powered at 50Hz		
pick-up	min %Us	75
	max %Us	115
drop-out	min %Us	20
	max %Us	55
of 50/60Hz coil powered at 60Hz		
pick-up	min %Us	80
	max %Us	115
drop-out	min %Us	20
	max %Us	55
AC average coil consumption at 20°C		
of 50/60Hz coil powered at 50Hz		
	in-rush VA	30
	holding VA	4
of 50/60Hz coil powered at 60Hz		
	in-rush VA	25
	holding VA	3
of 60Hz coil powered at 60Hz		
	in-rush VA	30
	holding VA	4
Dissipation at holding ≤20°C 50Hz	W	0.95
Max cycles frequency		
Mechanical operation	cycles/h	3600
Operating times		
Average time for Us control		
in AC		
Closing NO	min ms	12
	max ms	21
Opening NO	min ms	9
	max ms	18
Closing NC	min ms	17
	max ms	26
Opening NC	min ms	7
	max ms	17
in DC		
Closing NO	min ms	18
	max ms	25
Opening NO	min ms	2
	max ms	3
Closing NC	min ms	3
	max ms	5

Opening NC

min	ms	11
max	ms	17

UL technical data

Full-load current (FLA) for three-phase AC motor

at 480V	A	7.6
at 600V	A	6.1

Yielded mechanical performance

for single-phase AC motor

110/120V	HP	0.5
230V	HP	1.5

for three-phase AC motor

200/208V	HP	2
220/230V	HP	3
460/480V	HP	5
575/600V	HP	5

General USE

Contactor

AC current	A	20
------------	---	----

Contact rating of auxiliary contacts according to UL

A600 - Q600

Ambient conditions

Temperature

Operating temperature

min	°C	-50
max	°C	+70

Storage temperature

min	°C	-60
max	°C	+80

Max altitude

m 3000

Resistance & Protection

Pollution degree

3

Dimensions

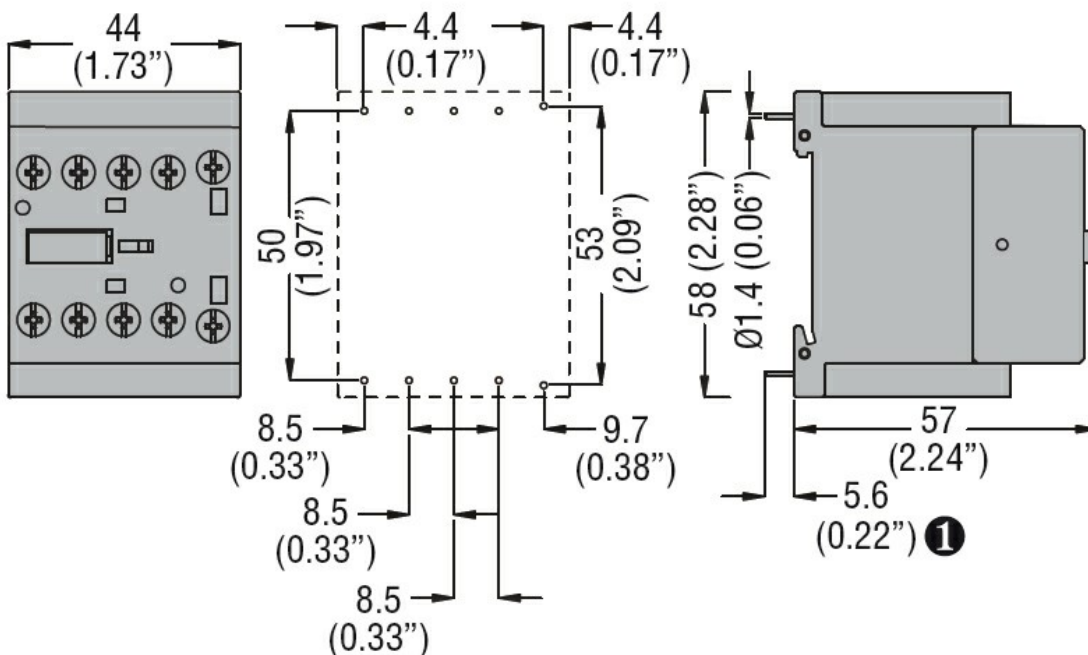

① Recommended PCB drillings 1.7-2mm.

Wiring diagrams

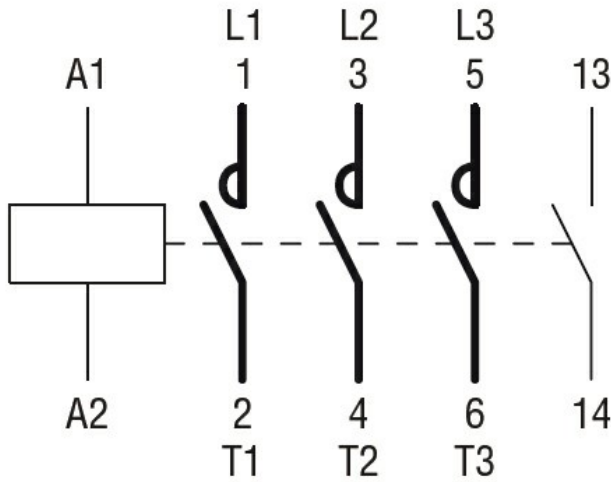

Certifications and compliance

Compliance

CSA C22.2 n° 60947-1

CSA C22.2 n° 60947-4-1

IEC/EN 60947-1

IEC/EN 60947-4-1

UL 60947-1

UL 60947-4-1

Certificates

cURus

EAC

ETIM classification

ETIM 8.0

EC000066 -
Power contactor,
AC switching