



Product designation				Power contactor
Product type designation				BG06
Contact characteristics				
Number of poles	Nr.			3
Rated insulation voltage U_i IEC/EN	V			690
Rated impulse withstand voltage U_{imp}	kV			6
Operational frequency	min	Hz	25	
	max	Hz	400	
IEC Conventional free air thermal current I_{th}	A			16
Operational current I_e	AC-1 ($\leq 40^\circ\text{C}$)	A	16	
	AC-1 ($\leq 55^\circ\text{C}$)	A	14	
	AC-1 ($\leq 70^\circ\text{C}$)	A	12	
	AC-3 ($\leq 440\text{V} \leq 55^\circ\text{C}$)	A	6	
	AC-4 (400V)	A	3.3	
Rated operational power AC-3 ($T \leq 55^\circ\text{C}$)	230V	kW	1.5	
	400V	kW	2.2	
	415V	kW	2.4	
	440V	kW	2.5	
	500V	kW	3	
	690V	kW	3	
Rated operational power AC-1 ($T \leq 40^\circ\text{C}$)	230V	kW	6	
	400V	kW	10	
	500V	kW	13	
	690V	kW	18	
IEC max current I_e in DC1 with $L/R \leq 1\text{ms}$ with 1 poles in series	$\leq 24\text{V}$	A	9	
	48V	A	8	
	75V	A	4	
	110V	A	3	
	220V	A	-	
IEC max current I_e in DC1 with $L/R \leq 1\text{ms}$ with 2 poles in series	$\leq 24\text{V}$	A	12	
	48V	A	11	
	75V	A	7	
	110V	A	6	
	220V	A	-	
IEC max current I_e in DC1 with $L/R \leq 1\text{ms}$ with 3 poles in series	$\leq 24\text{V}$	A	14	
	48V	A	14	
	75V	A	8	
	110V	A	8	

	220V	A	1
IEC max current I _e in DC1 with L/R ≤ 1ms with 4 poles in series	≤24V	A	–
	48V	A	–
	75V	A	–
	110V	A	–
	220V	A	–
IEC max current I _e in DC3-DC5 with L/R ≤ 15ms with 1 poles in series	≤24V	A	6
	48V	A	5
	75V	A	2
	110V	A	1
	220V	A	–
IEC max current I _e in DC3-DC5 with L/R ≤ 15ms with 2 poles in series	≤24V	A	7
	48V	A	7
	75V	A	4
	110V	A	3
	220V	A	–
IEC max current I _e in DC3-DC5 with L/R ≤ 15ms with 3 poles in series	≤24V	A	9
	48V	A	9
	75V	A	5
	110V	A	4
	220V	A	0,5
IEC max current I _e in DC3-DC5 with L/R ≤ 15ms with 4 poles in series	≤24V	A	–
	48V	A	–
	75V	A	–
	110V	A	–
	220V	A	–
Short-time allowable current for 10s (IEC/EN60947-1)		A	96
Protection fuse	gG (IEC)	A	16
	aM (IEC)	A	6
Making capacity (RMS value)		A	92
Breaking capacity at voltage	440V	A	72
	500V	A	72
	690V	A	72
Resistance per pole (average value)		mΩ	10
Power dissipation per pole (average value)	I _{th}	W	2.6
	AC-3	W	0.36
Tightening torque for terminals	min	Nm	0.8
	max	Nm	1
	min	I _{bin}	9
	max	I _{bin}	9
Tightening torque for coil terminal	min	Nm	0.8
	max	Nm	1
	min	I _{bin}	9

		max	lbin	9
Max number of wires simultaneously connectable			Nr.	2
Conductor section	AWG/Kcmil	max		12
Flexible w/o lug conductor section		min	mm ²	0.75
		max	mm ²	2.5
Flexible c/w lug conductor section		min	mm ²	1.5
		max	mm ²	2.5
Flexible with insulated spade lug conductor section		min	mm ²	1.5
		max	mm ²	2.5
Power terminal protection according to IEC/EN 60529				IP20 when properly wired

Mechanical features

Operating position		normal allowable		Vertical plan ±30°
Fixing				Screw / DIN rail 35mm
Weight			g	180
Conductor section	AWG/kcmil conductor section	max		12

Auxiliary contact characteristics

Thermal current I _{th}		A		10
IEC/EN 60947-5-1 designation				A600 - Q600
Operating current AC15		230V	A	3
		400V	A	1.9
		500V	A	1.4
Operating current DC12		110V	A	2.9
Operating current DC13		24V	A	2.9
		48V	A	1.4
		60V	A	1.2
		110V	A	0.6
		125V	A	0.55
		220V	A	0.3
		600V	A	0.1

Operations

Mechanical life		cycles		20000000
Electrical life		cycles		500000

Safety related data

Performance level B10d according to EN/ISO 13489-1		rated load	cycles	500000
		mechanical load	cycles	20000000
Mirror contacts according to IEC/EN 60947-4-1				yes
EMC compatibility				yes

AC coil operating

Rated AC voltage at 60Hz	V	120
AC operating voltage		
of 60Hz coil powered at 60Hz		
pick-up	min %Us	75
	max %Us	115
drop-out	min %Us	20
	max %Us	55
AC average coil consumption at 20°C		
of 50/60Hz coil powered at 50Hz	in-rush VA	30
	holding VA	4
of 50/60Hz coil powered at 60Hz	in-rush VA	25
	holding VA	3
of 60Hz coil powered at 60Hz	in-rush VA	30
	holding VA	4
Dissipation at holding ≤20°C 50Hz	W	0.95
Max cycles frequency		
Mechanical operation	cycles/h	3600
Operating times		
Average time for Us control		
in AC		
Closing NO	min ms	12
	max ms	21
Opening NO	min ms	9
	max ms	18
Closing NC	min ms	17
	max ms	26
Opening NC	min ms	7
	max ms	17
in DC		
Closing NO	min ms	18
	max ms	25
Opening NO	min ms	2
	max ms	3
Closing NC	min ms	3
	max ms	5
Opening NC	min ms	11
	max ms	17
UL technical data		
Full-load current (FLA) for three-phase AC motor		
	at 480V A	4.8
	at 600V A	3.9

Yielded mechanical performance

for single-phase AC motor

110/120V	HP	0.3
230V	HP	1

for three-phase AC motor

200/208V	HP	1.5
220/230V	HP	2
460/480V	HP	3
575/600V	HP	3

General USE

Contactor

AC current	A	16
------------	---	----

Short-circuit protection fuse, 600V

High fault

Short circuit current	kA	100
Fuse rating	A	30
Fuse class		J

Standard fault

Short circuit current	kA	5
Fuse rating	A	30

Contact rating of auxiliary contacts according to UL

A600 - Q600

Ambient conditions

Temperature

Operating temperature

min	°C	-50
max	°C	+70

Storage temperature

min	°C	-60
max	°C	+80

Max altitude

m 3000

Resistance & Protection

Pollution degree

3

Dimensions

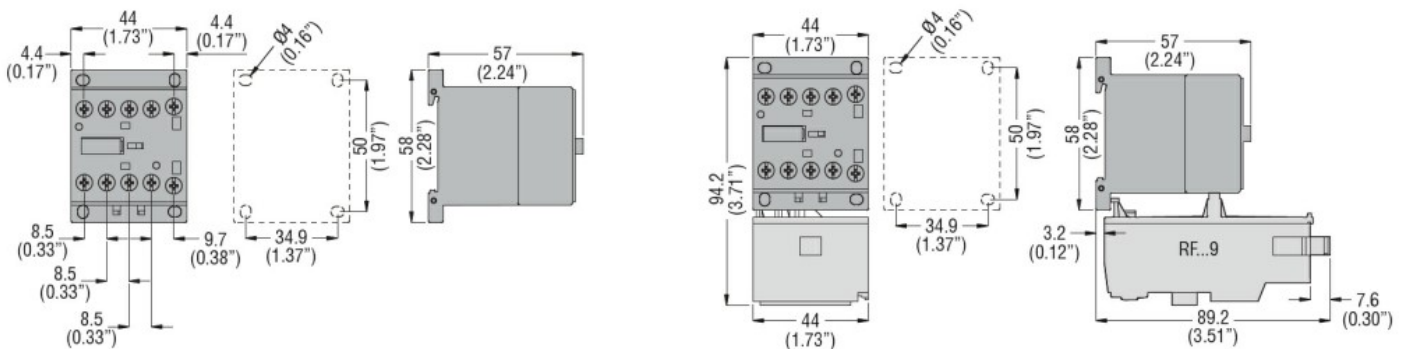

Wiring diagrams



Certifications and compliance

Compliance

CSA C22.2 n° 60947-1

CSA C22.2 n° 60947-4-1

IEC/EN 60947-1

IEC/EN 60947-4-1

UL 60947-1

UL 60947-4-1

Certificates

CCC

cULus

EAC

ETIM classification

ETIM 8.0

EC000066 -
 Power contactor,
 AC switching