



Product designation	Automatic battery chargers
Product type designation	BCF
Type	Single phase automatic battery charger 1 charging level for lead-acid batteries

Power supply

Rated voltage Us	min	VAC	100
	Max	VAC	240 ±10%
Operational frequency	min	Hz	50 ±5%
	max	Hz	60 ±5%
Power consumption	Max	VA	150
	Max	W	70
Power dissipation Max		W	9
Internal fuse		A	2

Charging cycle

Reference standards	IEC62368-1
Battery type	lead-acid
Battery voltage	VDC 12
Charging voltage (Uc)	13.6 VDC
Charging current (Ic)	A 4.5
Charging current adjustment	% Ic Fixed

Protections	Main supply fuse; charging inhibition due to: 1. Short circuit at battery terminals; 2. Reverse battery polarity; 3. Low voltage at battery poles; 4. Output overload.
-------------	--

Indications

LED reverse battery polarity	Yes
------------------------------	-----

Alarm output circuit

Output type	1 relay
Rated capacity	AC1: 3A 250VAC

Mechanical features

Housing type	Modular DIN rail mounting
Terminals type	Fixed

Fixing	35mm DIN rail or Screw fixing		
Weight	g	332	
Ambient conditions			
Temperature	Operating temperature		
	min	°C	-40
	max	°C	+51
	Storage temperature		
	min	°C	-40
	max	°C	+85
Protection degree	IP20		

Dimensions

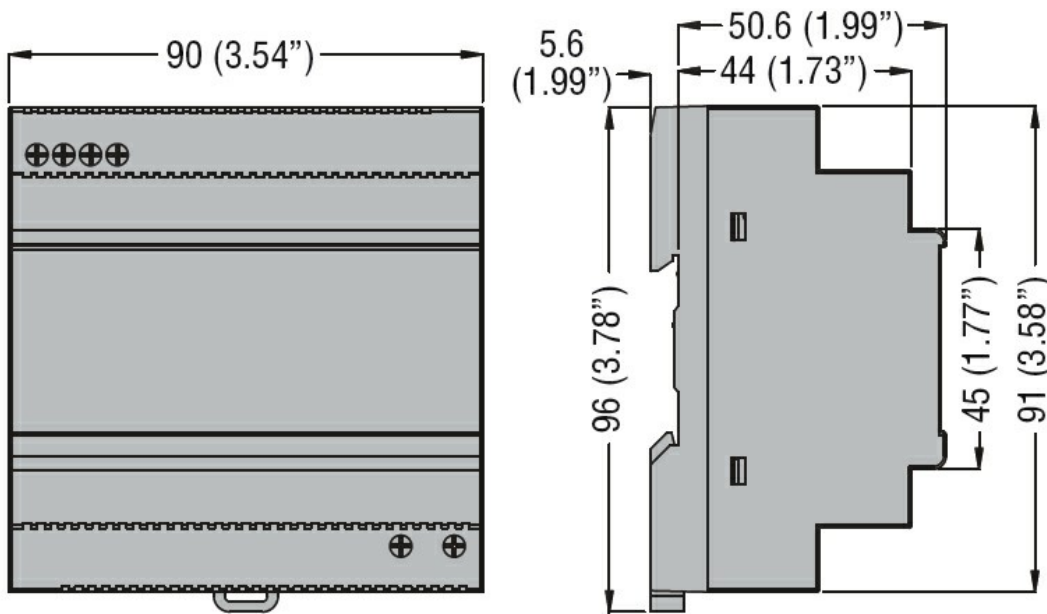

Wiring diagrams

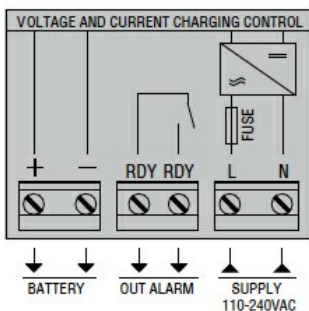

Certifications and compliance

Compliance

IEC/EN/BS 60100-6-2
IEC/EN/BS 61000-6-3
IEC/EN/BS 62368-1

Certificates

cURus
EAC

ETIM classification

ETIM 8.0

EC000359 -
Universal charger